



BUILD WITH CONFIDENCE

METRO SOFA ELITE E-MODULAR



Application

Airport Terminal | Railway Station | Metro Station | Bus Terminal
Hospital | Banks | Diagnostic Centre | Other Public Seating Areas.

METRO SOFA ELITE E-MODULAR

3 SEATER

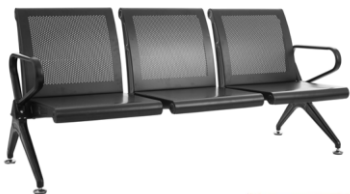

SPECIFICATION

*WARRANTY APPLICABLE ONLY
FOR MANUFACTURING DEFECTS



SEAT & BACK

PROCESSED WITH 1.0 MM THICKNESS COLD ROLLED
FURNISHED WITH POWDER COATING.

ARMREST

PROCESSED WITH 1.2 MM ERW TUBE AND FURNISHED WITH
POWDER COATING

LEG

PROCESSED WITH 1.0 MM THICKNESS COLD ROLLED SHEET
AND FURNISHED WITH POWDER COATING.

CENTER SUPPORT BEAM

PROCESSED WITH 2.0 MM THICKNESS MS SEAT AND ALSO
FURNISHED WITH POWDER COATING

METRO SOFA ELITE E-MODULAR

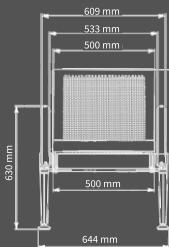

**METRO SOFA ELITE
E-MODULAR - 1 SEATER**

WEIGHT

NET WEIGHT - 13.76 KG

GROSS WEIGHT - 15.51 KG

**METRO SOFA ELITE
E-MODULAR - 2 SEATER**

WEIGHT

NET WEIGHT - 22.72 KG

GROSS WEIGHT - 24.29 KG

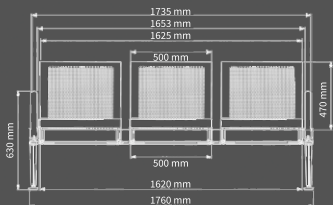
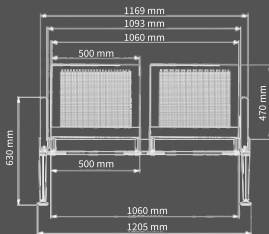

**METRO SOFA ELITE
E-MODULAR - 3 SEATER**

WEIGHT

NET WEIGHT - 31.18 KG

GROSS WEIGHT - 33.32 KG

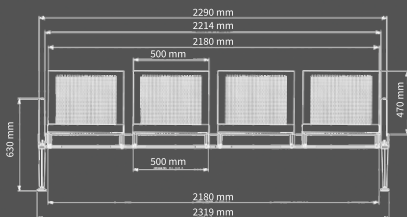

METRO SOFA ELITE E-MODULAR - 4 SEATER

WEIGHT | NET WEIGHT - 40.01 KG | GROSS WEIGHT - 43.08 KG

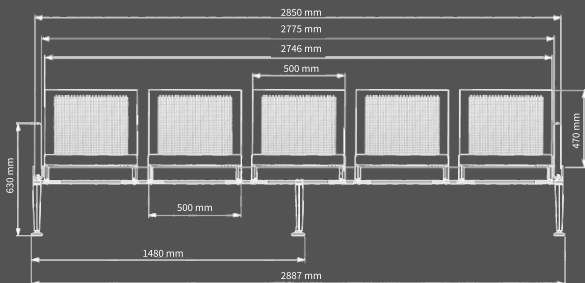

METRO SOFA ELITE E-MODULAR - 5 SEATER

WEIGHT | NET WEIGHT - 50.25 KG | GROSS WEIGHT - 53.74 KG

*All dimensions are in MM

COMPONENTS IN METRO SOFA 3-SEATER ELITE E-MODULAR KIT

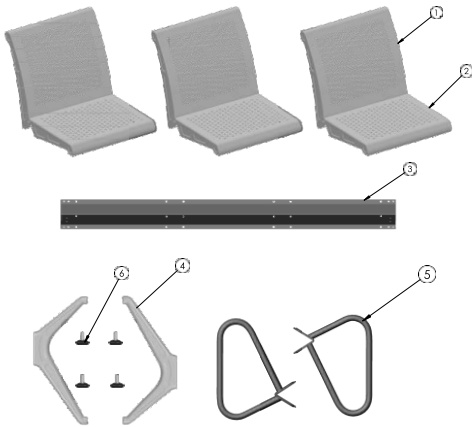

S.No	Part Name	Quantity
1	Back	3
2	Seat	3
3	Centre Beam	1
4	Leg	2
5	Arm Rest	2
6	Leveller Cup	4

METRO SOFA SEAT & BACK ASSEMBLY

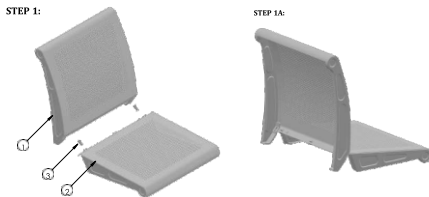

S.No	Part Name	Quantity
1	Back	1
2	Seat	1
3	M8 X 20	6

ASSEMBLY INSTRUCTION :

STEP 1 : Insert the seat slot into back and insert the bolt M8 x 20mm left and right side

STEP 1A: Do Same bolt fixing in the seat and back assy

METRO SOFA LEG ASSEMBLY

STEP 2:



STEP 2A:



STEP 3:

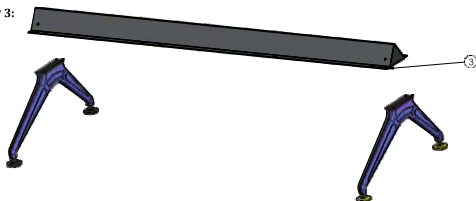

S.No	Part Name	Quantity
1	Leg	1
2	Leveller Cup	2
3	Center Beam	1

ASSEMBLY INSTRUCTION :

STEP 2 : Place the Leveller on the legs in center holes

STEP 2A : Fasten the Leveller on both the legs.

STEP 3 : Place the Legs on both end of centre beam at location leg top side holes

METRO SOFA LEG, CENTER BEAM & WEDGE ASSEMBLY

STEP : 3A

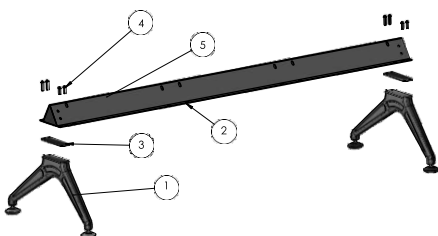

STEP : 3B

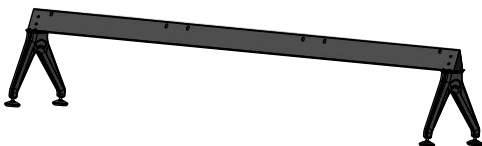

S.No	Part Name	Quantity
1	Leg Assembly	2
2	Center beam	1
3	wedge	2
4	M8X35	4
5	M8X25	4

ASSEMBLY INSTRUCTION :

STEP 3A : Place the Center Beam on the legs. Place the wedge between leg & center beam fasten the M8 Bolts into the both center beam & wedge & leg holes with allen key

STEP 3B : Bolts are the tighten both gradually right & left side. Don't go over tight the bolt separately

METRO SOFA SEAT, BACK & CENTER BEAM ASSEMBLY

STEP 4:

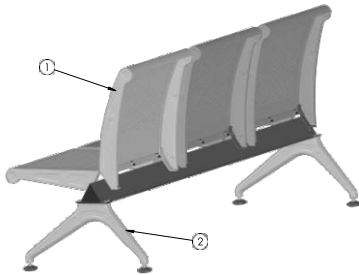

STEP 4A:



S.No	Part Name	Quantity
1	seat assembly	3
2	Leg & center beam Assembly	2

ASSEMBLY INSTRUCTION :

STEP 4 : Place the seat & back on the center Beam.

STEP 4A : Locate the Seat & Back on Centre beam mounting holes.

STEP 5:

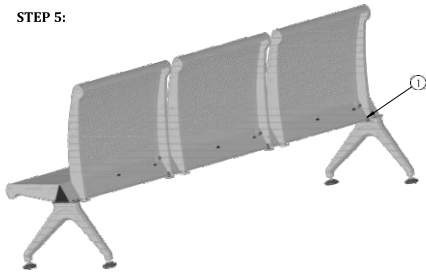

STEP 6:

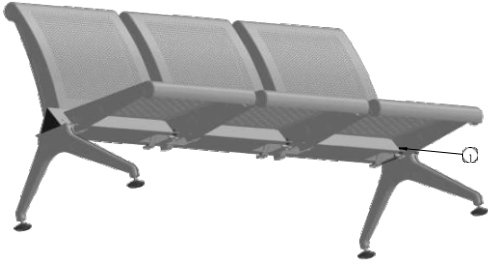

S.No	Part Name	Quantity
1	M10 x 25mm	12

ASSEMBLY INSTRUCTION :

STEP 5 : Insert the M10 bolt on bottom side of the back with the centre beam.

STEP 6 : Tighten the bolts 1,2 & 3 in sequence as shown in the figure.

ARMRST ASSEMBLY

S.No	Part Name	Quantity
1	ARM REST	2
2	M8X25	6



ASSEMBLY INSTRUCTION :

STEP 7 : Attach arm to the center beam. Insert M8 bolts and fasten the arm to the center beam end.

STEP 8 : Fasten the bolts with arm to the center beam both ends

STEP :7

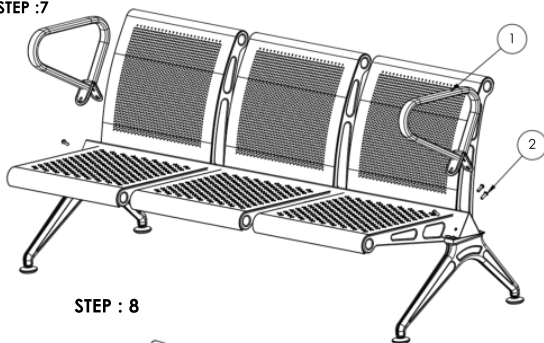

STEP : 8

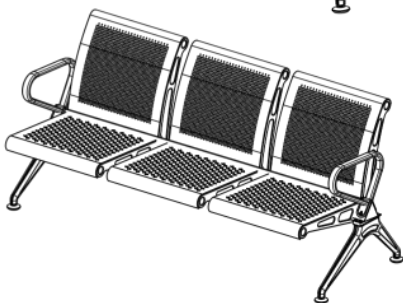

ASSEMBLY INSTRUCTION :

STEP 9 : Fasten all the bolts & check carefully the joints. Metro sofa three seater is ready to use.

S.No	Part Name	Quantity
1	Seat	3
2	Back	3
3	Arm Rest	2
4	Centre Beam	1
5	Leg	2
6	Leveller Cup	4

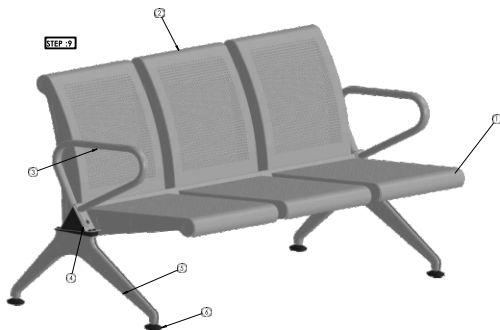

PACKING STANDARD





CURVY ERGONOMIC DESIGN



ADDRESS :

No.36/8, Balfour Road, Kilpauk, Chennai - 10.
Ph. No: +91 98417 98417 | Website : www.mbmindia.co.in

Email : sales@mbmindia.co.in